

# Helixon-S



①



②





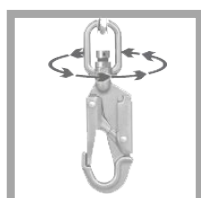

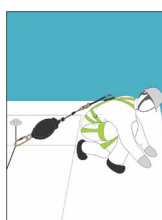
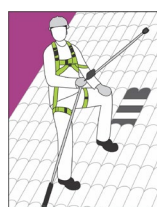
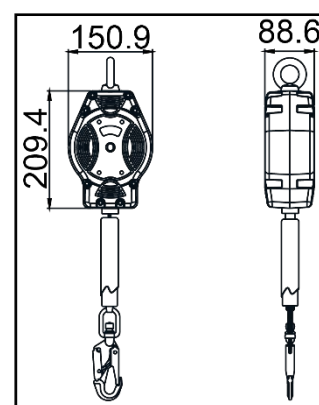
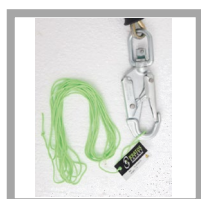

③



④

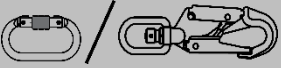

|   |
|---|
| HS CODE   |
| 84251910  |
| CARTON SIZE / PCS.  |
| 60 x 40 x 24 cm / 4   |
| AET N°2777/10828-02/E01-01  |
| <b>Satra Technology Europe Ltd., N° 2777,</b><br>Bracetown Business Park, Clonee,<br>Dublin, D15YN2P, Ireland |
| MODULE D F14/14003.02   |
| <b>SGS Fimko Oy, N°0598</b><br>Takomotie 8,<br>00380 HELSINKI, Finland  |

|   |   |
|---|---|
| REF.  | FA 20 504 06  |
| LG.<br> KG | 6 m   |
| CE  | 100 KG  |
| MAT.<br>   | Polyamide 6 - 30% fiber glass<br>PES 25 mm  |
|            | <br>FA 50 101 17 / FA 50 203 20 with fall indicator |
|           | X2  |
| R(kN)   | 15 kN   |
|          | YES – 100 KG  |
|          | 2.33 KG   |



**Longueur** Poids maxi utilisateur  
**Length** Max. user weight  
**Longitud** Peso máximo del usuario  
**Lunghezza** Peso Max. dell'utente  
**Länge** Höchstgewicht des Benutzers

MAT.



**Matière carter / sangle**  
 Material of casing / webbing  
**Material cárter / correa**  
 Material dei carter / Cinghia  
**Material Gehäuse / Gurt**

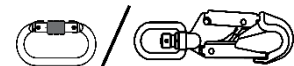

**Matière connecteur haut / connecteur bas**  
 Material of top connector / bottom connector  
**Material conector alto / conector bajo**  
 Materiale connettore alto / connettore basso  
**Material oberes / unteres Verbindungselement**



**Nombre d'émerillons**  
 Number of swivels  
**Cantidad de eslabones giratorios**  
 Numero di tornichetti  
**Anzahl der Wirbel**



**Homologué pour le travail à proximité d'arêtes vives**  
 Approved for work near sharp edges  
**Homologado para trabajo cerca de aristas vivas**  
 Omologato per lavoro in prossimità di spigoli vivi  
**Zugelassen für Arbeiten in der Nähe scharfer Kanten**