

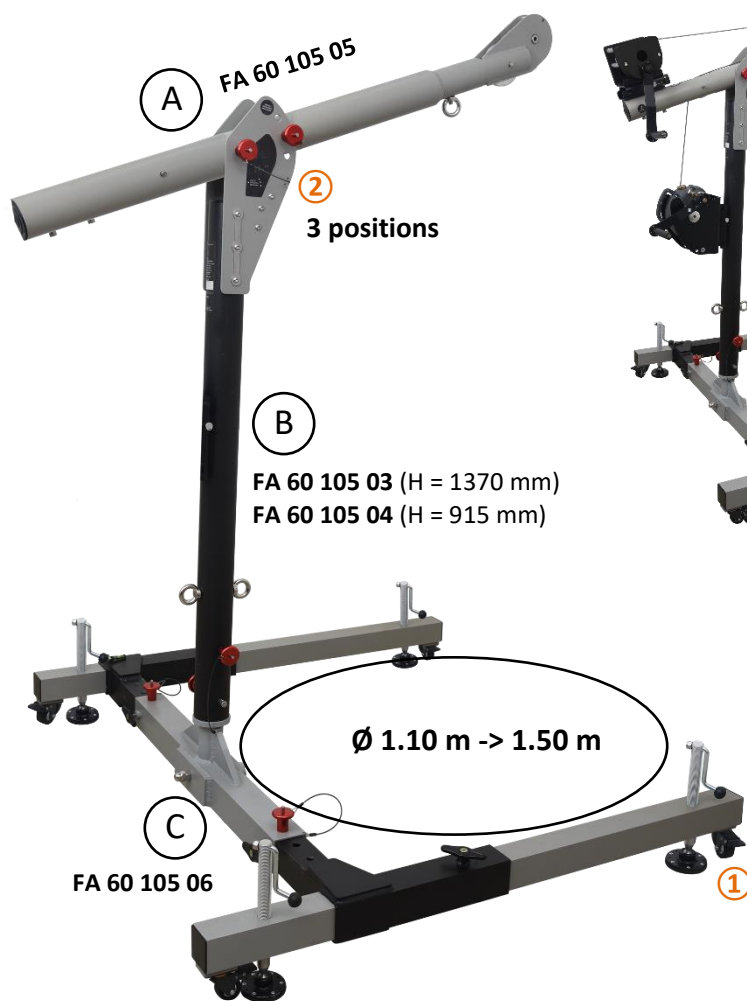

FA 60 105 00, FA 60 105 07







EASY SAFEWAY 1

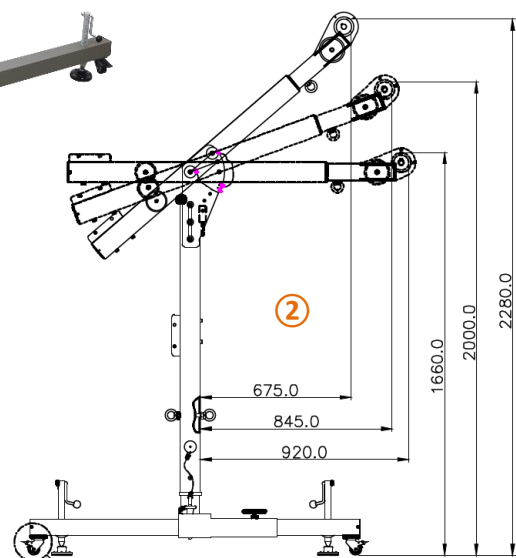

FA 60 105 00 =	FA 60 105 07 =
FA 60 105 03	FA 60 105 04
+ FA 60 105 05	+ FA 60 105 05
+ FA 60 105 06	+ FA 60 105 06



HS CODE
7616 9990 99
CARTON SIZE / PCS.
A FA 60 105 05 : 157 x 25 x 20 cm / 1 pc. B FA 60 105 03 : 157 x 25 x 20 cm / 1 pc. OR B FA 60 105 04 : 120 x 25 x 20 cm / 1 pc. C FA 60 105 06 : 144 x 67 x 40 cm / 1 pc.
AET (UE) N° (in progress)
Satra Technology Europe Ltd., N° 2777, Bracetown Business Park, Clonee, Dublin, D15YN2P, Ireland
MODULE D FI14/14003.02
SGS Fimko Oy, N°0598 Takomotie 8, 00380 HELSINKI, Finland

REF.	FA 60 105 00 FA 60 105 07								
CE	EN 795:2012 Type B								
	x1								
	500 KG								
MAT.									
DIM. \updownarrow H	3 positions : 1.66 m / 2.00 m / 2.28 m								
R (kN) / MBS (kN)	12 kN / 21 kN								
	Min. 1,10 m / Max. 1,50 m								
+	(1) Machinery Directive + EN 1808 (2) FA 60 022 00/01/02/11/12/13 (2) FA 60 105 01 + FA 20 401 XX/FA 20 401 XXS (3) FA 60 105 02 + FA 60 003 XX/FA 60 003 XXS/FA 60 023 20/FA 60 023 20R								
	<table border="0"> <tr> <td>62 KG</td> <td>58,35 KG</td> </tr> <tr> <td>A 11 KG</td> <td>A 11 KG</td> </tr> <tr> <td>+ B 16 KG</td> <td>+ B 12.35 KG</td> </tr> <tr> <td>+ C 35 KG</td> <td>+ C 35 KG</td> </tr> </table>	62 KG	58,35 KG	A 11 KG	A 11 KG	+ B 16 KG	+ B 12.35 KG	+ C 35 KG	+ C 35 KG
62 KG	58,35 KG								
A 11 KG	A 11 KG								
+ B 16 KG	+ B 12.35 KG								
+ C 35 KG	+ C 35 KG								



Nombre d'utilisateurs
Number of users
Cantidad de usuarios
Quantità di utilizzatori
Anzahl der Benutzer

R (kN) / MBS (kN)

Résistance statique (en kN) / Résistance à la rupture
Static strength / Minimum Breaking Strength
Resistencia estática (en kN) / Resistencia a la ruptura (en kN)
Resistenza statica (in kN) / Resistenza alla rottura (in kN)
Statische Festigkeit (in kN) / Bruchfestigkeit (in kN)



Charge maxi admissible
Max. allowable load
Carga máxima admisible
Peso massimale
Zulässige Höchstlast

DIM. \updownarrow H

Hauteur
Height
Altura
Altezza
Höhe

+ (1)

Point fort
Key feature
Ventaja principal
Punti forti
Produktvorteil



Empattement base en H
H-shaped wheelbase
Distancia entre ejes de base en H
Ingombro base a H
Standbreite Basis in H

+ (2)

À utiliser avec
To be used with
Para usar con
Ad essere utilizzato con
Verwendet werden soll mit