

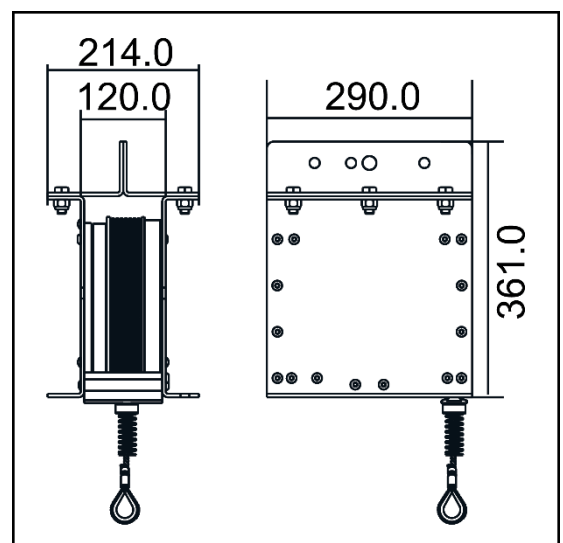







LA 10 1000 11



HS CODE
84798997
CARTON SIZE / PCS.
48 x 32 x 39 cm / 1

REF.	LA 10 1000 16
LG 	11 m
CE	Machinery Directive 2006/42/EC
MAT. 	 
	---
+	INDICATOR
	30 KG

LG



Longueur Charge maxi admissible
Length Max. allowed load
Longitud Carga máxima admisible
Lunghezza Carico massimale ammissibile
Länge Zulässige Höchstlast

INDICATOR

Équipé d'un témoin de chute
 Has a fall indicator
Equipado con un testigo de caída
 Con indicatore di caduta
Mit Sturzindikator

MAT.



Matière carter / câble
 Material of casing / wire rope
Material cárter / cable
 Material dei carter / cavo
Material Gehäuse / Seil



Nombre d'émerillons
 Number of swivels
Cantidad de eslabones giratorios
 Numero di tornichetti
Anzahl der Wirbel